

Battery Chargers & Testers

Lubrication & Sealants

Exhaust Hoses & Tailpipe Adapters

Bench Grinders & Shop Vises

Pliers & Screwdrivers

Shop Cleaners & Brushes

Shop Lights

Service Stickers

Tire Displays & Carts

Interior Protection Products

Studding Equipment

Drains, Pumps & Fluid Exchange

Safety Products

Wheel Chocks

Mechanic's Gloves

AUTO & FLEET SERVICE

AUTEL MAXIBAS BATTERY & ELECTRICAL SYSTEM ANALYZERS

BT608

STAY CURRENT

INTELLIGENT BATTERY SERVICE



POWERED BY
AUTEL
DIAGNOSTICS



Bluetooth VCI Unit

Clamp Cables Thermal Paper Roll



ADAPTIVE LOAD & CONDUCTANCE



BMS RESET FUNCTIONALITY



SYSTEM DETECTION

BATTERY & ELECTRICAL SYSTEM DIAGNOSTICS **FASTER VEHICLE ID: AUTOVIN & VINSCAN**

- 5.5" Touchscreen / Android 9.0 / Wi-Fi Software Updates
- Test 6 & 12 Volt Batteries: 100 - 3000 CCA
- Test 12 & 24 Volt Cranking / Charging Systems

- Battery Specific System & Location Confirmation
- Test Battery / Charging System for Proper Function
- Electrical System Reset

AUTEL MAXIBAS
BATTERY & ELECTRICAL SYSTEM ANALYZERS



SCAN TO WATCH
TRAINING VIDEOS
YouTube



AUTEL



Battery Chargers & Testers

12V 10A PROSERIES RAPID CHARGER

ASCOT NO.	MFG. NO.	DESCRIPTION
341-00117	DSR117	12V 10A ProSeries Rapid Charger



341-00117

6V/12V 125A PROSERIES BATTERY CHARGER/ENGINE STARTER

ASCOT NO.	MFG. NO.	DESCRIPTION
341-00118	DSR118	6V/12V 125A ProSeries Battery Charger/Engine Starter



341-00118

PROSERIES 12V 2200 PEAK AMP JUMP STARTER WITH USB AND DC POWER

ASCOT NO.	MFG. NO.	DESCRIPTION
341-00114	DSR114	ProSeries 12V 2200 Peak Amp Jump Starter with USB and DC Power



341-00114



341-00119

PROSERIES 1800 PEAK AMP JUMP STARTER

ASCOT NO.	MFG. NO.	DESCRIPTION
341-00119	DSR119	ProSeries 1800 Peak Amp Jump Starter

12V 250A PROSERIES BATTERY CHARGER/ENGINE STARTER

ASCOT NO.	MFG. NO.	DESCRIPTION
341-00121	DSR121	12V 250A ProSeries Battery Charger/Engine Starter



341-00121

6/12V 275A PROSERIES BATTERY CHARGER/ENGINE STARTER

ASCOT NO.	MFG. NO.	DESCRIPTION
341-00122	DSR122	6/12V 275A ProSeries Battery Charger/Engine Starter



341-00122

341-01352

6/2/40/20/250/125A 12/24V AUTOMATIC BATTERY CHARGER/ENGINE STARTER

ASCOT NO.	MFG. NO.	DESCRIPTION
341-01352	SC1352	6/2/40/20/250/125A 12/24V Automatic Battery Charger/Engine Starter

AUTO & FLEET SERVICE

Lubricants & Sealants

B'LASTER PENETRATING LITHIUM GREASE

- High-quality lithium grease
- Time-release penetrating action
- Superior lubrication & protection
- QUANTITY: 6 per case

ASCOT NO.	MFG. NO.	DESCRIPTION
328-00008	GR-8A-PB	B'laster Penetrating Lithium Grease, 8 oz.



328-00008

B'LASTER MAX HD GREASE

- Excellent high-temp lubrication • Superior corrosion protection • Does not drip in severe conditions • Protects up to high temperatures of 550°F (dropping point) • QUANTITY: 10 per case

HIGH TEMP
LUBRICATION
FORMULA

ASCOT NO.	MFG. NO.	DESCRIPTION
328-00014	GR-14C-HDG	B'laster Max HD Grease, 14 oz.



328-00014

B'LASTER SILICONE LUBE

- Teflon™ fluoropolymer enhances performance • Long-lasting lubrication • Won't accumulate dust & dirt • QUANTITY: 12 per case

LONG
LASTING

ASCOT NO.	MFG. NO.	DESCRIPTION
328-00016	16-SL	B'laster Silicone Lube, 11 oz.



328-00016



PROTECTS
AGAINST
RUST

ASCOT NO.	MFG. NO.	DESCRIPTION
328-00114	GR-14C-HTR	B'laster Extra Tacky Red Grease, 14 oz.

B'LASTER PENETRATING GREASE

- High-quality synthetic grease • Time-release penetrating action • Superior anti-seize properties • Superior grease fitting lubrication & protection • QUANTITY: 10 per case

ASCOT NO.	MFG. NO.	DESCRIPTION
328-00314	GR-14C-PB	B'laster Penetrating Grease, 14 oz.



328-00314

B'LASTER ALL-PURPOSE LUBRICANT

- Teflon™ fluoropolymer reduces friction & wear • Protect surfaces • Over 1000 indoor & outdoor applications • Enhance performance • Light vanilla scent • Use on all moving parts • QUANTITY: 12 per case

ASCOT NO.	MFG. NO.	DESCRIPTION
328-00050	PB-50	B'laster All-Purpose Lubricant, 8 oz.



328-00050



B'LASTER EXTRA TACKY RED GREASE

- Maximum anti-wear & extreme pressure protection • Resists thinning in high temps (550°F dropping point) • Protects against rust & corrosion • QUANTITY: 10 per case

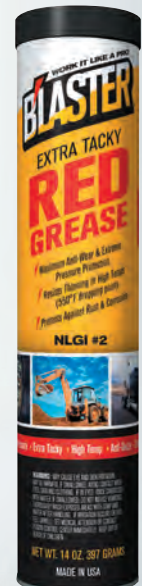

328-00114





B'LASTER DRY LUBRICANT

- Teflon™ fluoropolymer helps reduce friction & wear • Enhance performance • Protect surfaces
- QUANTITY: 12 per case

ASCOT NO.	MFG. NO.	DESCRIPTION
328-00116	16-TDL	B'laster Dry Lubricant, 9.3 oz.



328-00116



328-00214

B'LASTER PRO GRADE MULTI-PURPOSE GREASE

- Superior general purpose lubrication
- Protects against rust & corrosion
- Excellent water resistance
- QUANTITY: 10 per case



ASCOT NO.	MFG. NO.	DESCRIPTION
328-00214	GR-14C-MP	B'laster Pro Grade Multi-Purpose Grease, 14 oz.

B'LASTER CITRUS DEGREASER

- Fast-acting formula rinses clean with water
- Safely cleans stainless steel • Spray on & wipe off tough grease • QUANTITY: 12 per case



ASCOT NO.	MFG. NO.	DESCRIPTION
395-00016	16-CBD	B'laster Citrus Degreaser, 11 oz.

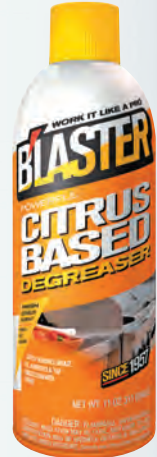

395-00016

B'LASTER GARAGE DOOR LUBE

- Teflon™ fluoropolymer reduces friction & wear • Won't accumulate dust & dirt • Quiets noisy operation • QUANTITY: 12 per case



ASCOT NO.	MFG. NO.	DESCRIPTION
395-00116	16-GDL	B'laster Garage Door Lube, 9.3 oz.



395-00116

B'LASTER PARTS WASH SOLVENT

- Cuts through cutting oil, motor oils & grease • HIGH FLASHPOINT FORMULA: 145°F
- Leaves parts residue free
- Safe for use on all metals, most plastics & painted surfaces



393-00005

393-00128

ASCOT NO.	MFG. NO.	DESCRIPTION
393-00128	128-PWS	B'laster Parts Wash Solvent, 1-Gallon (4 per case)
393-00005	5-PWS	B'laster Parts Wash Solvent, 5-Gallon Pail

B'LASTER WHITE LITHIUM GREASE

- Keep surfaces lubricated in extreme temperatures
- Protects against moisture & oxidation • Leaves a thick layer of grease • QUANTITY: 12 per case



ASCOT NO.	MFG. NO.	DESCRIPTION
395-00216	16-LG	B'laster White Lithium Grease, 11 oz.



395-00216

AUTO & FLEET SERVICE

Exhaust Hoses & Tailpipe Adapters

CRUSHPROOF EXHAUST VENTILATION SYSTEM

DOOR PORTS



391-00130

391-00125

Y-CONNECTORS



391-00240

391-00230

SPLICE CONNECTORS



391-21040

391-20040

ELBOWS



391-00430

391-00330

OVERHEAD DUCT



391-22040

Y-ASSEMBLY



391-53000

ASCOT NO.	MFG. NO.	DESCRIPTION
391-00125	DF25	2-1/2" Rubber Door Port
391-00130	ADF30	3" Aluminum Door Port
391-00140	ADF40	4" Aluminum Door Port
391-00225	RY25	2-1/2" Rubber Y-Connector
391-00230	RY30	3" Rubber Y-Connector
391-00240	AY40	4" Aluminum Y-Connector
391-20030	AC30	3" Aluminum Splice Connector
391-20040	AC40	4" Aluminum Splice Connector
391-20050	AC50	5" Aluminum Splice Connector
391-20060	AC60	6" Aluminum Splice Connector
391-21025	SP25	2-1/2" Rubber Splice Connector
391-21030	SP30	3" Rubber Splice Connector
391-21040	SP40	4" Rubber Splice Connector
391-00325	AEL25	2-1/2" Aluminum Elbow
391-00330	AEL30	3" Aluminum Elbow
391-00340	AEL40	4" Aluminum Elbow
391-00350	AEL50	5" Aluminum Elbow
391-00425	EB25	2-1/2" Rubber Elbow
391-00430	EB30	3" Rubber Elbow
391-22150	OC50D	5" Overhead Duct Connector W/Damper
391-22160	AC-60-OC	6" Overhead Duct Connector
391-22030	OC30	3" Overhead Duct Connector
391-22040	OC40	4" Overhead Duct Connector
391-22050	OC50	5" Overhead Duct Connector
391-52500	YA250	2-1/2" Y-Assembly
391-53000	YA300	3" Y-Assembly
391-54000	YA400	4" Y-Assembly

FLARELOK® HOSES

• For use with cars and small trucks • Flared end on each length to permit connection of two or more lengths of same size hose



391-15350

ASCOT NO.	MFG. NO.	DESCRIPTION
391-15250	FLT250	2-1/2" x 11' Flarelok® Hose
391-15300	FLT300	3" x 11' Flarelok® Hose
391-15350	FLT350	3-1/2" x 11' Flarelok® Hose
391-15400	FLT400	4" x 11' Flarelok® Hose

TAILPIPE ADAPTERS

• Crushproof offers a complete line of accessory items



ASCOT NO.	MFG. NO.	DESCRIPTION	TAILPIPE STYLE	TAILPIPE SIZE	HOSE ID
391-93000	TPA3000	Split Adapter	Separated	Up To 2-1/2"	3"
391-90250	F250	Straight W/ Hook & Chain	Single	Up To 2"	2-1/2", 3", 3-1/2"
391-90300	F300	Straight w/ Hook & Chain	Single	Up To 2-1/2"	2-1/2", 3", 3-1/2"
391-90350	F350	Straight w/ Hook & Chain	Single	Up To 3"	2-1/2", 3", 3-1/2"
391-90400	F400	Straight w/ Hook & Chain	Single	Up To 3-12/16"	3-1/2", 4", 5
391-90600	DSR600	Stack Adapter	Diesel Stack	Up To 5-1/2"	4", 5"
391-90606	DSR600-6	Stack Adapter	Diesel Stack	Up To 5-1/2"	5", 6"
391-91000	UNA1000	Narrow Dual	2.5"	2.5"	3"
391-90475	F475	Oval Adapter (2.5" x 6")	Twin Oval	2", 5-1/2"	3", 4"
391-90575	F575	Oval Adapter (3.5" x 8.5")	Twin Oval	2", 5-1/2"	3", 4"
391-91250	RA250	Bell w/Snaps	All	All	3"
391-91300	RA300	Bell w/Snaps	All	All	3"

Bench Grinders & Shop Vises



INDUSTRIAL BENCH GRINDERS

- UL listed motor • Pre-lubricated and enclosed ball bearings • Cast iron wheel guards and dust vents • One piece quick adjusting spark guards • Large eye shields with quick adjustment
- Adjustable tool rests • Heavy duty guarded toggle switch on 8" and 10" • Fine and coarse vitrified wheels included • Rubber mounts prevent movement • 3-conductor cord with 3-prong plug



311-77101



311-77172

ASCOT NO.	MFG. NO.	DESCRIPTION
311-77101	577101	JBG-6A: Bench Grinder, 6" Wheel
311-77102	577102	JBG-8A: Bench Grinder, 8" Wheel
311-77103	577103	JBG-10A: Bench Grinder, 10" Wheel
311-77172	577172	JPS-2: Optional Pedestal

6" SWIVEL BASE BENCH VISE

- Heavy duty 30,000 PSI castings for long life and added strength • Swivel bar rotates 360° and has double lockdowns ensuring maximum stability • Powder coat paint resists scratches and provides a tough durable finish • Replaceable hardened steel top and pipe jaws



311-21500



BENCH GRINDER MODELS AT A GLANCE

Model No.	JBG-6A	JBG-8A	JBG-10A
ASCOT. No.	311-77101	311-77102	311-77103
Shaft Diameter (In.)	1/2	5/8	1
Wheel Diameter (Dia. x W/ In.)	6 x 3/4	8 x 1	10 x 1
Wheel Speed (RPM)	3450	3450	1725
Wheel Grits	36/60	36/60	24/46
Motor (HP)	1/2HP, 115V, 1Ph	1HP, 115V, 1Ph	1-1/2HP, 115V, 1Ph
Overall Dimensions (LxWxH/ In.)	18 x 10-1/2 x 8-1/2	19 x 12-1/2 x 10	24-1/2 x 12-1/4 x 13
Net Weight (Lb.)	38	60	110

ASCOT NO.	MFG. NO.	JAW WIDTH	THROAT DEPTH	PIPE CAP.	WT.
311-21500	21500	6"	4-1/8"	1/4 - 3-1/2	69.35 lb.

AUTO & FLEET SERVICE

Bench Grinders & Shop Vises (cont.)



PROFESSIONAL SHOP VISES

- Cast iron jaw with heavy internal ribs for added strength. Pipe jaws are permanently cast in for greater channel strength
- Cast iron back jaw designed for exceptional alignment with the front jaw
- "V" notched, replaceable/reversible jaws made of carbon steel and heat treated for extra strength
- Specially designed spring loaded handle and screw guarantees quick jaw response
- Front jaw beam covers and protects screws
- Steel handle balls forged from handle stock
- Lifetime Casting Warranty

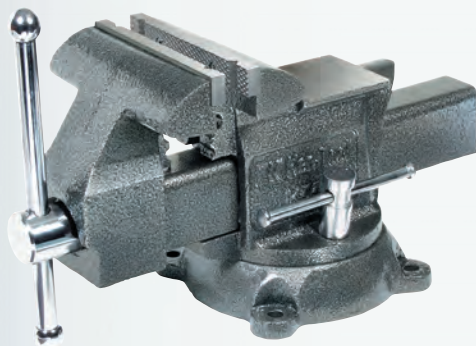

311-64055

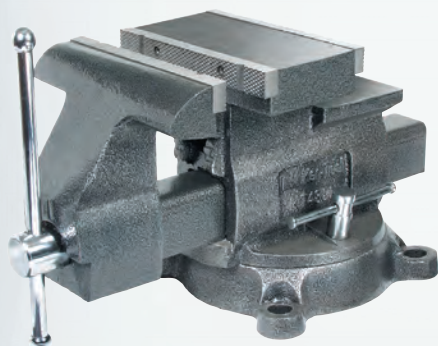

311-64800

ASCOT NO.	MFG. NO.	JAW WIDTH	JAW OPENING	THROAT DEPTH	PIPE CAP.	WEIGHT
311-64055	64055	5-1/2"	6-1/2"	3-3/16"	1/8"	30 lb.
311-64065	64065	6-1/2"	7-1/2"	3-3/4"	1/8"-2-1/2"	41 lb.
311-64650	64650	6-1/2"	7"-10"	3-3/16"	1/8"-2-1/2"	50 lb.
311-64800	64800	8"	8"-11"	3-3/4"	1/8"-3"	74 lb.

TRADESMAN VISES

- Fully sealed one-piece spindle nut assembly for a lifetime of smooth operation
- Precision machined slide bar to eliminate movement in front jaw regardless of opened position
- 60,000 PSI ductile iron body, jaw & base
- Machined steel serrated jaws with black phosphate coating for increased durability and corrosion resistance
- Lifetime Warranty



311-28806

ASCOT NO.	MFG. NO.	JAW WIDTH	OPENING CAPACITY MAX.	THROAT DEPTH	PIPE JAW CAPACITY	WEIGHT
311-28805	28805	4-1/2"	3-1/2"	3-1/2"	1/4" - 3-1/2"	42 lb.
311-28806	28806	5-1/2"	5"	3-5/8"	3/8" - 3-1/2"	42 lb.
311-28807	28807	6-1/2"	6"	4-1/4"	3/8" - 4"	42 lb.
311-28808	28808	8"	6-3/4"	5"	3/8" - 4-1/2"	111 lb.

MECHANICS PRO VISES

- Enclosed Spindle for smooth operation
- Precision machined slide bar to eliminate movement in front jaw regardless of opened position
- Needle roller thrust bearing to easily apply and release clamping force
- 60,000 PSI Jaw and Base
- Lifetime Warranty



311-28811



ASCOT NO.	MFG. NO.	JAW WIDTH	OPENING CAPACITY MAX.	THROAT DEPTH	PIPE JAW CAPACITY	WEIGHT
311-28810	28810	4-1/2"	4"	3-1/2"	1/4" - 3"	31 lb.
311-28811	28811	5-1/2"	5"	3-5/8"	1/4" - 3"	38 lb.
311-28812	28812	6-1/2"	6"	4-3/8"	1/4" - 4"	56 lb.
311-28813	28813	8"	8-1/2"	4-1/2"	1/2" - 4"	83 lb.
311-28814	28814	10"	12"	5-1/4"	1/2" - 5"	115 lb.

Pliers & Screwdrivers



CHANNELLOCK PLIERS

- 100% MADE IN USA
- LASER heat-treated cutting edges perform better and last longer
- FORGED high carbon U.S. steel for maximum strength and durability is specially coated for ultimate rust prevention
- CHANNELLOCK BLUE® grips for comfort



ASCOT NO.	MFG. NO.	DESCRIPTION
319-00337	337	7" High Leverage Diagonal Cutting Plier
319-00357	357	7" End Cutting Plier
319-00358	358	8" End Cutting Plier
319-00436	436	6" Diagonal Cutting Plier, Box Joint
319-00526	526	6" Slip Joint Plier, Wire Cutting Shear



8-PIECE PROFESSIONAL SCREWDRIVER SET

- Includes 5 flat tip drivers and 3 Phillips tip drivers:
- SLOTTED: 3/8" x 8", 5/16" x 6", 1/4" x 4", 3/16" x 3", 1/4" x 1-1/2"
- PHILLIPS: #2 Phillips x 4", #1 Phillips x 3", #2 Phillips x 1-1/2"
- Black handles
- Hardened chrome vanadium shafts • Vapor blasted magnetic tips • Packaged in molded plastic tray for storage • Hex bolsters for extra turning power



ASCOT NO.	MFG. NO.	DESCRIPTION
319-19800	19800	8-Piece Professional Screwdriver Set

1/4" SOCKET DRIVER

- Shank made from chrome vanadium • Overall Length: 6" • Shank Length: 2-1/2" • Ideal for use with the TPMS 11mm x 12mm flip socket
- Screwdriver handle, made from durable plastic-like material • MADE IN THE USA

ASCOT NO.	MFG. NO.	DESCRIPTION
319-72521	7252100	1/4" Socket Driver with Screwdriver Handle



AUTO & FLEET SERVICE

Shop Cleaners & Brushes



FLOOR SQUEEGEES

- Black neoprene rubber blade designed for rough, heavy use • Handle not included, order separately



ASCOT NO.	MFG. NO.	DESCRIPTION
395-45507	45507	24" Straight Squeegee
395-44020	44020	Handle

PALMYRA FILL GARAGE BRUSHES/BROOMS

- Excellent for heavy duty sweeping of concrete, sidewalks and garage floors • Can be used for wet or dry sweeping



ASCOT NO.	MFG. NO.	DESCRIPTION
395-42023	42023	24" Garage Brush-Palmyra

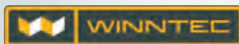

PREMIUM HAND WIPES

Winntec's premium hand wipes are the perfect way to keep clean in any workshop.

- Powerful cleaning
- Moisturizing • Great for hands and surfaces
- Water saving • 336 wipes per box



ASCOT NO.	MFG. NO.	DESCRIPTION
395-83039	G083039	Premium Hand Wipes



PLASTIC HANDLED BRASS SIDEWALL BRUSH

- Densely packed brass bristles • Great for cleaning white sidewall tires • BRISTLE LENGTH: 3/4" • OVERALL LENGTH: 8-1/4" • Plastic handle fits comfortably in the hand



ASCOT NO.	MFG. NO.	DESCRIPTION
395-13124	VT-932	Plastic Handled Brass Sidewall Brush

WOODEN HANDLED WIRE BRUSH WITH METAL SCRAPER

- Cleans rust from rims and wheels • 19 rows of steel bristles • Slightly curved wooden handle • Metal scraper included • BRISTLE LENGTH: 1" • OVERALL LENGTH: 14-1/4"



ASCOT NO.	MFG. NO.	DESCRIPTION
535-00150	VT-931	Wooden Handled Wire Brush with Metal Scraper

395-83039



FULL BORE HAND CLEANER

- Rids hands of dirt and grease while leaving the skin soft and chap free
- Solvent free
- Economical
- Contains skin moisturizers
- Clean fragrance
- Never irritates or burns open wounds
- Rinses clean
- Keeps your sink clean
- Keeps your pipes clean
- Will not separate during hot months
- Long shelf life
- Neutral pH
- MEETS AMERICAN CLEAN WATERS ACT

RIDS HANDS OF DIRT AND GREASE

LEAVES HANDS SOFT AND CHAP FREE



395-00101



395-00102



395-00103



395-00104



395-00300



395-00125



395-00126

ASCOT NO.	MFG. NO.	DESCRIPTION
ULTRA FLOW		
395-00101	TSIGAL	Ultra Flow, 1 Gallon
395-00102	TSIGAL-FT	Ultra Flow, 1 Gallon Flat Top
395-00103	TSIGAL-16OZ	Ultra Flow, 16 oz. **
ULTRA FLOW DISPENSERS		
395-00104	Plastic Pump	Plastic Pump
395-00300	TS300-D	Stainless Steel Screw On Dispenser **
395-00125	TS125-D	Stainless Steel Wall Mount Dispenser
395-00126	TS125-FT-D	Stainless Steel Wall Mount Dispenser (Fits Flat Top)
SUPER GRIT		
395-40000	TS4000	Super Grit, 4 Gallon **
395-06400	TS6400	Super Grit, 64 oz.
EXTREME GREEN		
395-00400	MG-HS-4GAL	Extreme Green, 4 Gallon **
395-06401	MG-HS-64OZ	Extreme Green, 64 oz.



395-40000



395-00400



395-06400



395-06401

AUTO & FLEET SERVICE



Shop Lights

COB RECHARGEABLE WORK LIGHT W/ USB CABLE

- 400LM brightness • Dimming Switch
- Features a hook on lamp head and base with magnet for hands-free operation
- WORKING TIME: Approx. 2.5 hrs. • CHARGING TIME: Approx. 4 hrs. • 8W COB LED



312-03007

HEAD LIGHT WITH RECHARGEABLE BATTERY

- Hands-free, versatile and comfortable with adjustable straps • MATERIAL: Aluminum +ABS+PC • LED: 1-piece high power CREE T6 bulb • BRIGHTNESS: Approx. 500LM for high mode • 4-MODE LED LAMPS: High - Low - Strobe - off • WORKING TIME: Approx. 6 hours on High; Approx. 12 hours on Low • CHARGING TIME: Approx. 5 hours • RECHARGEABLE BATTERIES: 2x 3.7V 1800mAh Li-ion batteries (3600mAh total battery capacity) • Sensor Function • USB cable included



312-03120

RECHARGEABLE WATERPROOF WORK LIGHT

- Best in the industry, Ascot Supply Corporation's Rechargeable Waterproof Work Light is the brightest rechargeable work light available with its powerful 66 LED's (460 lumens) • Swivel hook for hanging • Universal attachment hook can be used as a light stand or attached under a car hood • Rechargeable battery • Replacement 12 V lighter adapter is also available and sold separately



312-05224

312-25224

ASCOT NO.	MFG. NO.	DESCRIPTION
312-03007	TWL3007E	COB Rechargeable Work Light w/ USB Cable

ASCOT NO.	MFG. NO.	DESCRIPTION
312-03120	THL2019	CREE Head Light with Rechargeable Battery

ASCOT NO.	MFG. NO.	DESCRIPTION
312-05224	CED5224A-AS	Rechargeable Waterproof Work Light
312-15224	CED522P3-AS	Replacement AC Adapter for Rechargeable Waterproof Work Light
312-25224	CED5224P1-AS	12V Lighter Adapter for Rechargeable Work Light

Service Stickers

STATIC CLING PRINTER

- Full feature Reminder Sticker Solution takes professionalism to a new level
- Godex Printer pre-programmed to work out of the box
- 1 year parts and labor warranty (6 months on print head)
- Includes 1 ribbon



399-11111

ASCOT NO.	MFG. NO.	DESCRIPTION
399-11111	FK-GX001-05	Static Cling Printer

STATIC CLING REMINDER STICKERS

- Excellent item to promote repeat business
- Keeps your name, the service to be done and the time to do it in constant view of the customer
- More effective than a door jam sticker
- Static cling vinyl will cling to almost any smooth surface
- No adhesive residue and they can be removed for cleaning and replacing
- Silk screen printing process for a high quality image and a writing strip that won't allow the ink to fade
- Generic design stickers as well as personalized stickers



399-00101



399-00102



399-00103

ASCOT NO.	DESCRIPTION
399-00101	Air Pressure/Tire Rotation Static Cling Sticker
399-00102	Oil Change Static Cling Sticker
399-00103	Service Reminder Static Cling Sticker

Tire Displays, Racks & Carts



WALL MOUNT TIRE RACK

- Designed and tested to meet your toughest standards • 500 lb./227 kg of tire and wheel assemblies kept off the floor to let you do the jobs that matter • Long heavy-duty steel tubes of 83"/2108 mm to hold 8 SUV tire and wheel assemblies (8 x 245 tread) • DIMENSIONS: 81-9/16" X 23-7/8" X 25-7/8" • MAX TIRE SIZE: 865 mm / 34" OD) • TIRE CAPACITY: 8 to 9 • LOAD CAPACITY: 500 lb./224 kg • WEIGHT: 42 lb.



751-00080

ASCOT NO.	MFG. NO.	CAPACITY	DIMENSIONS
751-00080	MWM-80	8-9 Tires	81-9/16" x 23-7/8" x 25-7/8"

DELUXE TIRE DISPLAY ON CASTERS

- Provides an excellent compromise between strength and lightness
- Equipped with casters that let you move it quickly and easily
- Allows you to store 16 tires with an outside diameter of up to 32"



751-00072

ASCOT NO.	MFG. NO.	CAPACITY	DIMENSIONS
751-00072	MTD-72	14-16 Tires	77" x 26-1/2" x 89"



STANDARD TIRE DISPLAY ON CASTERS

- The standard tire display is 60" long and holds up to 14 tires, 7 on each of 2 tiers • This model is used a great deal by Goodyear and Michelin • With 2 wheels and 2 steel feet, moving this rack requires the display truck. The truck acts as a lever, facilitating handling in snow, on gravel surfaces and on inclines



751-00060

ASCOT NO.	MFG. NO.	CAPACITY	DIMENSIONS
751-00060	MTD-60	10-14 Tires	64-1/2" x 26-1/2" x 76-1/2"



DOLLY FOR TIRE DISPLAYS

- Required to handle tire display units • Only one is necessary even if you have several display units • Compatible with all other makes of display units



751-00172

ASCOT NO.	MFG. NO.	DESCRIPTION
751-00172	MD	Dolly for Tire Displays



TIRE RIDER TUFF TIRE CART

• Easy to maneuver, even with a full load of tires • Can handle tires up to 35" in diameter • Features a gas spring that automatically closes the arms and grips the tires • All you have to do is to push down on the pedal, slide the cart under the stack of tires and release the pedal. The frame lines up the tire on its own • Allows you to move tires 12 to 35 inches in size



EASY TO MANEUVER

703-00810

ASCOT NO.	MFG. NO.	CAPACITY	DIMENSIONS
703-00810	MTC-E	6 to 8 tires	35" O.D. Max

SMART TIRE CART

• Works on passenger 15" tires up to truck size 245/70R19.5 tires • Moves mounted tires and wheel sets • Moves tires in stacks of 8 to 10 high • Stacks tires closer together than other carts which creates more storage space • No foot pedals • Great for loading and unloading trucks and containers • Patented tilting action relieves stress off the user • New push/pull system pushes the tires out of the SMART Cart arms without stress • Fewer moving parts • Easy to assemble • "Patent Pending"



703-47147

PATENTED TILT ACTION RELIEVES STRESS

NEW PUSH/PULL SYSTEM

ASCOT NO.	MFG. NO.	CAPACITY	DIMENSIONS
703-47147	G471147HD	8 to 10 tires	Handles sizes from 15" to truck size 245/70R19.5

TIRE CART REPLACEMENT TIRES/WHEELS

Sold as a pair of two • Flat-free foam design • SIZE: 10" x 3-1/2" • Industrial inner & outer wheel bearings • Compatible with Martins tire carts



703-00818

ASCOT NO.	MFG. NO.	DESCRIPTION
703-00818	PU1005ASC	Tire Cart Replacement Tires/Wheels

TIRE DOLLY W/ CASTERS

Includes (4) swivel, non-marking and smooth 3" casters, (1) equipped with brake • 300 lb. capacity • Ideal for moving tires around or for tire storage • Unique built-in compartment stackable design for space saving storage • SIZE: 25.2" x 25.2" x 4.33"



703-00509

ASCOT NO.	MFG. NO.	DESCRIPTION
703-00509	TC0509	Tire Dolly w/ Casters

AUTO & FLEET SERVICE



Interior Protection Products



The Slip-N-Grip® protection system provides total protection for the customer's car while being serviced:

- Covers hold fast to the upholstery: A patented process laminates two distinctly different plastics together - the top layer allows a person to easily slide into and out of the vehicle and the bottom, or gripping layer, keeps the seat cover in place
- Unique process eliminates static electric clinging and wrinkling.

A complete line of vehicle interior protection products are available along with a service center roll dispenser.

PARTS RETURN BAG

- Heavy plastic bag for holding old removed parts you've replaced • Keeps customer's vehicle and hands clean

ASCOT NO.	MFG. NO.	DESCRIPTION	SIZE
399-60098	FB-P9943-56	Parts Return Bag	14" x 22"

PAPER KEY TAG

- Cost-effective, convenient solution for key control • Metal ring

ASCOT NO.	MFG. NO.	DESCRIPTION	SIZE	QUANTITY
399-98313	FB-P9833-13	Paper Key Tag with Metal Rings	1.5" x 2.75"	1,000/box

PLASTIC KEY TAG

- Self-locking design holds keys secure • Large writing surface; holes are fully punched out eliminating "chads"
- Perfect for quickly tagging keys in a busy service area

ASCOT NO.	MFG. NO.	DESCRIPTION	QUANTITY
399-99323	FB-P9933-23	White Plastic Key Tag - 4.5" x .75"	1000/package

WORK TICKET HOLDER

- Heavy-duty sewn nylon fabric handle ensures durability even in harsh conditions • Durable brass grommet increases strength

ASCOT NO.	MFG. NO.	DESCRIPTION	SIZE	QUANTITY
399-99302	FB-P9933-02	Work Ticket Holder	10.5" x 14.5"	25/box

PLASTIC FLOOR MAT

- Slip-N-Grip® two-layer construction ensures mat stays in place • Impervious to water, oil, grease and most shop chemicals

ASCOT NO.	MFG. NO.	DESCRIPTION	QUANTITY
399-99432	FG-P9943-02	Plastic Floor Mat	500/roll

GENERIC ADHESIVE TIRE LABEL

- Features sure-grip adhesive • Proper used tire labeling sells tires

ASCOT NO.	MFG. NO.	DESCRIPTION	QUANTITY
399-99479	FB-P9943-79	Generic Adhesive Tire Label - 3" x 6"	500/roll

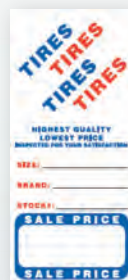

399-99479



399-99432



399-98313

399-99323

399-99302



PLASTIC TIRE BAG

• 40% post-consumer recycled resin • White film hides dirty tire • Ideal for returning old tires or snow tires for storage

ASCOT NO.	MFG. NO.	DESCRIPTION	SIZE	QUANTITY
399-99391	FG-P9933-91	Extra Large Tire Bag	47" x 48" x 1.25 Mil	125/roll
399-99429	FG-P9943-29	Standard Tire Bag	36" x 40"	250/roll
399-99392	FG-P9933-92	Large Tire Bag	39" x 44"	250/roll

399-99429



PLASTIC SEAT COVER

• Slip-N-Grip® seat covers have two distinct layers: the bottom layer grips the seat to stay in place and the top layer is smooth to allow easy entry and exit from the vehicle • Protects bucket, bench and split seats

ASCOT NO.	MFG. NO.	DESCRIPTION	QUANTITY
399-99415	FG-P9943-15	Plastic Seat Cover	500/roll

399-99415



STEERING WHEEL COVER

• Keeps grease, dirt and other shop chemicals off • Made of clear polyethylene with stretch elastic grip feature • Unique double-band steering wheel covers stays in place while allowing access to airbags

STANDARD SIZE: Covers virtually all passenger cars and light trucks.

ASCOT NO.	MFG. NO.	DESCRIPTION	QUANTITY
399-99433	FB-P9943-33	Double Band Steering Wheel Cover (Standard Size)	500/box
399-99435	FB-P9943-35	Double Band Steering Wheel Cover (For Trucks)	250/box

399-99433



FLOOR-RACK START-UP KIT

• Promotes your professional image by displaying your complete line of car interior protection products where your customers can see you putting them in their car • Convenient roll dispenser work station provides organized storage, helps save employee time and shows your customers you care about their car

ASCOT NO.	MFG. NO.	DESCRIPTION
399-60000	FK-P9943-76	Product Dispenser System (Includes Product)

FLOOR DISPENSER RACK

• Industry-leading dispenser system keeps products organized and within reach • Presents "We Care" image and promotes cleanliness • Retention straps prevent free-rolling and locking casters keep dispenser in place • Top tray holds paper floor mats and other service items while lower tray provides extra storage

ASCOT NO.	MFG. NO.	DESCRIPTION
399-98893	FB-P9833-89	Floor Dispenser Rack

399-98893



399-60000

Interior Protection Products (cont.)



PERSONALIZED PAPER FLOOR MATS

• Either insert your logo where the footprints are or totally design a new layout • The stock is a high bulk 60 pound white sheet, size 17" x 22", with a one color imprint • Minimum order of 3,000 • Camera ready art must be supplied for all logos - one time artwork charge

ASCOT NO.	DESCRIPTION
399-00005	Personalized Paper Floor Mats

PRIME HEAVY DUTY PAPER FLOOR MATS

• Treated/coated mats, made from premium prime/virgin paper • Keeps dirt, grease, oil, spills, leaks and other shop fluids out of your customer's vehicle during service • Prime paper is suitable for all weather climates and heavy foot traffic • Prime paper directly from paper mill provides same consistent quality every time • Printed with UV ink • Bright white paper produces vibrant, full color prints • Recyclable • SIZE: 17" x 19" • QUANTITY: 500 per box

ASCOT NO.	MFG. NO.	DESCRIPTION
399-74980	M3273PP2280A	Prime Heavy Duty Paper Floor Mats - 17" x 19"

PLASTIC ARROW KEY TAG

• Unique one piece key tag that attaches easily to the key ring with a hole for hanging on a board • Packaged 40 perforated sheets with 25 tags each • 1000 per pack

ASCOT NO.	DESCRIPTION
399-00011	Plastic Arrow Key Tag

TIRE LABELS

• 2-1/2" x 6" label for easy identification of new, used and retreaded tires • Packed 500 per roll

ASCOT NO.	MFG. NO.	DESCRIPTION
601-00101	TL-101	Tire Labels New-Used-Retread

399-00005



399-74980



601-00101

Stud Guns & Studding Equipment

STUD GUN, STUDDING EQUIPMENT



ASCOT NO.	MFG. NO.	DESCRIPTION
458-00010	10-G	Stud Gun. Standard of the Industry. Automatic, Light weight
458-00002	KFP2	Stud Feeder. Fully automatic with 110 Volt motor, fast loading. Provides positive stud orientation. Feeds up to 225 studs per minute
458-04048	4048	Feederboy Stud Gun. Designed for fast feeding studs of the AS-9 Gun Attaches with screw clamp. Operates by manually turning the feeder cap
458-00005	K-5	Stud Feeder. INCLUDES: shield for gun. Welded steel construction with saddle
458-00500	K-500	Studding Equipment Kit. INCLUDES: K-5 stand, AS-9 gun, KFP2 automatic stud feeder

UGRIP®, SELF-ADJUSTING CARBIDE TIRE STUD

• Delivers full-time traction, increases the safety, convenience and security • To order studs to best fit your customers' tire, use the TSMI number recommended by the tire manufacturer



SINGLE FLANGE STUDS:

TSMI Size	11	12	13	15	169	17	19
Overall Length	.345"	.375"	.470"	.520"	.585"	.515"	.635"
Jacket Dia.	.197"	.197"	.197"	.197"	.197"	.197"	.250"
Bottom Dia.	.354"	.354"	.354"	.354"	.354"	.354"	.354"
Nearest 32" to Hole Depth	11/32"	12/32"	13/32"	15/32"	16/32"	17/32"	19/32"

STUDDING EQUIPMENT

• Lightweight, reduces road wear • Steel 12SL, 13SL & 16SL meet requirements for Washington, Oregon & Idaho

ASCOT NO.	STUDDING GUN	USE WITH STUDS NUMBERED
458-00010	10G	TSMI-11-12-13-15-16-17
458-00011	10T	TSMI-19-21

PARTS BREAKDOWN

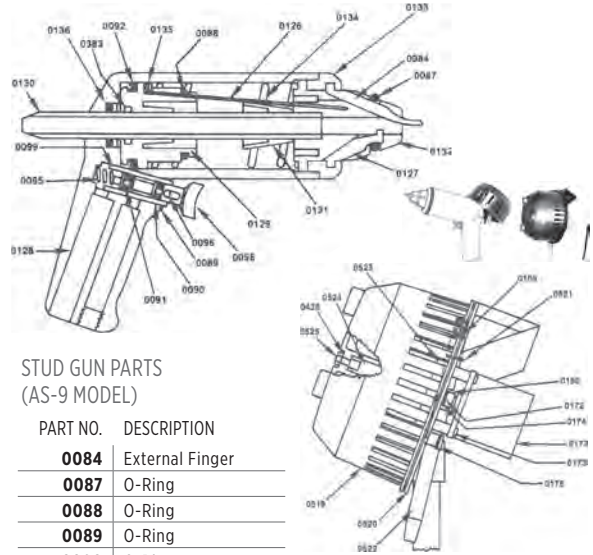

STUD GUN PARTS (AS-9 MODEL)

PART NO.	DESCRIPTION
0084	External Finger
0087	O-Ring
0088	O-Ring
0089	O-Ring
0090	O-Ring
0091	O-Ring
0092	Piston Cup
0095	Trigger Spring
0096	Trigger Pin
0098	Trigger
0099	Trigger Sleeve
0126	Pressing Spring
0127	Internal Finger
0128	Handle Body
0129	Piston
0130	Feed Tube
0131	Tapered Sleeve
0132	Head (Steel)
0133	Ring Nut
0134	Compression Spring
0135	Ring
0136	O-Ring
0383	Piston Cup

STUD FEEDER PARTS (KFP2 MODEL)

PART NO.	DESCRIPTION
0169	Deflector Spring
0172	Snap Ring
0173	Screw
0174	Washer
0175	Clamp
0180	Drive Shaft Pin
0428	Washer
0519	Feed Wheel
0520	Base Plate
0521	Retaining Ring
0522	Feed Tube
0523	Screw
0524	Shaft
0525	Hex Bolt

STUD GUN REPAIR & CONVERSION KITS

ASCOT NO.	STUDDING GUN	USE WITH STUDS NUMBERED
458-03810	0381	Tire Stud Mini Repair Kit. INCLUDES: (3) 0084 External Fingers; (1) 0087 O-ring; (1) 0088 O-ring; (3) 0126 Pressing Springs
458-03820	0382	Tire Stud Gun Large Repair Kit. INCLUDES: (6) 0126 Pressing Spring; (3) 0084 External Fingers; (2) 0087 O-ring; (2) 0088 O-ring; (1) 0092 Piston Cup; (1) 0136 O-ring
458-00911	00911	Conversion Kit. Converts AS-9 Gun to AS-11 Truck Model. INCLUDES: (1) 0401 Truck Feed Tube; (1) 0400 Truck Stud Gun Head; (3) 0127 Truck Stud Gun Internal Finger



Drains & Pumps

18-GALLON POLYETHYLENE WASTE OIL DRAIN

- 18 gallon capacity
- Plastic drain container
- Comes with 16.5" funnel
- Extends from 40" to 73"
- Metal trolley comes with 4 casters and pull handle for safe and easier movement around the shop
- Oil can be drained either by pour gravity, integrated drain valve or using integrated bung hole rotary barrel pump (not included)
- SHIP WEIGHT: 24 lbs.

ASCOT NO.	MFG. NO.	DESCRIPTION
329-08874	8874	18-Gal Polyethylene Waste Oil Drain



329-08874

18-GALLON LOW PROFILE WASTE OIL DRAIN

- Low profile drain height of 7.75"
- Large 18 gallon baffled tank reduces "slosh" during transport
- Large metal screen provides extra draining area and keeps out debris
- Convenient rotary hand pump for fast evacuation
- Long steel handle provides easy mobility to drain area
- SHIP WEIGHT: 47 lbs.

ASCOT NO.	MFG. NO.	DESCRIPTION
329-08878	8878	18-Gal Low Profile Waste Oil Drain



329-08878

24-GALLON WASTE OIL DRAIN

- Large 24 gallon steel recovery tank with 6' drain hose
- Tank-mounted oil-level sight gauge and convenient tool tray
- Standard 15-3/4" drain funnel and wide 24" funnel adapter (shown) with drain tube that extends from 54" to 79"
- Pressure regulator
- Heavy duty wheels and casters
- SHIP WEIGHT: 82 lbs.

ASCOT NO.	MFG. NO.	DESCRIPTION
329-08890	8890	24-Gal Waste Oil Drain with Pressurized Evacuation



329-08890



329-08895

24-GALLON WASTE OIL DRAIN WITH PROBE KIT

- 18 gallon suction capacity
- 100 PSI shop air connected to vacuum gauge quickly creates suction
- Large 16" collection funnel (4-7/8 gallon capacity)
- Suction extraction at 1/2 gallon per minute
- 78" suction and drain hoses
- Pressurized evacuation of tank makes emptying easy
- 70.8" maximum height
- Six flexible evacuation probes and VW, Mercedes and BMW adapters
- Two air ports: 1 for pressure, 1 for vacuum
- SHIP WEIGHT: 93 lbs.

ASCOT NO.	MFG. NO.	DESCRIPTION
329-08895	8895	24-Gal Waste Oil Drain/Evacuator with Probe Kit





ROLLING FLOOR TRUCK DRAIN

• Comes pre-assembled allowing for immediate use • Can be used for used motor oil or Antifreeze; decals provided for fluid identification • FEATURES: Two fixed wheels and 1 swivel caster, double baffles with upper screen and side splash lip • 3/4" or 1" Coupler kit sold separately

322-41203



ASCOT NO.	MFG. NO.	CAPACITY	DESCRIPTION
322-41203	4120-003	5.2-Gallon	Truck Drain for Antifreeze
322-41467	4140-067	—	Cam-Lock Coupler, Adapter and Valve Kit (3/4") for 4120-003 drain
322-41206	4120-006	26-Gallon	Truck Drain for Motor Oil
322-41461	4140-061	—	Cam-Lock Coupler, Adapter and Valve Kit (1") for 4120-003 drain



LOW PROFILE TRUCK OIL DRAIN WITH LID

• Holds 60 quarts • Equipped with 4 rollers and a handle for transport and positioning under trucks • Cover and curved side design help keep fluids from spilling during movement • Convenient handles and pour spout facilitate fluid evacuation • Rolls under most cab over axles so oil can be changed without jacks or jack stands • OVERALL HEIGHT: 7-1/2", WIDTH: 32-1/4", LENGTH: 49"



322-19202

ASCOT NO.	MFG. NO.	DESCRIPTION
322-19202	19202	Low Profile Truck Oil Drain with Lid

TRUCK & TRAILER WHEEL PAN

• Prevents oil mess during wheel repair • The pan fits rims with 13 3/4" ID and larger • Handle compartments hold hub nuts out of the oil • Made of polypropylene for durability • Will not warp if oil is warm • CAPACITY: 88 ounces



322-19852

ASCOT NO.	MFG. NO.	DESCRIPTION
329-19852	19852	Truck & Trailer Wheel Pan

AUTO & FLEET SERVICE

Drains & Pumps (cont.)

TRANSMISSION DRAIN FUNNEL

- 22" by 23" heavy duty plastic lift drain funnel
- Extends the catch area of any lift drain
- Funnel catches any loose parts
- Prevents parts from falling through drain



322-17892

ASCOT NO.	MFG. NO.	DESCRIPTION
322-17892	17892	Transmission Drain Funnel



DUNK TANKS

- Heavy duty plastic tire and tube test tank
- Features pyramid type ribs for extra support to prevent bowing
- Handles passenger tire sizes to wide oval and light duty truck tires



322-19822

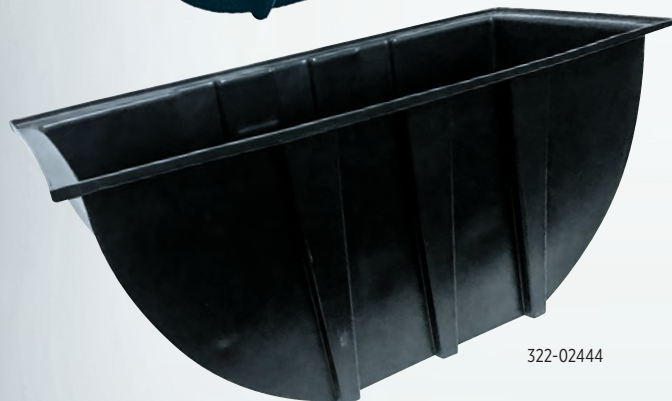

322-02444

ASCOT NO.	MFG. NO.	DESCRIPTION
322-19822	2400-10	Passenger Car
322-02444	2400-44	SUV/Light Truck



MULTI-DRAIN TUB

- 30-quart, all purpose, heavy duty, plastic drain tub
- For draining radiator, crankcase, transmission differential
- Accommodate autos and trucks
- Apron for washing and sorting parts



322-17922

ASCOT NO.	MFG. NO.	DESCRIPTION
322-17922	17922	Multi-Drain Tub

4.5-GALLON OVAL DRAIN PAN

- New, smooth pan design is easy to wipe out and clean
- 6.25" pan height to fit tight spaces
- 1.125" outer diameter spout for quick and easy pouring of used fluids into most jugs
- Anti-splash lip helps prevent spills when carrying or pouring
- Multiple hand positions for carrying
- Made of high density polyethylene material that is resistant to chemicals and solvents



322-17972



322-17982

ASCOT NO.	MFG. NO.	DESCRIPTION
322-17972	17972	Black Drain Pan (For Oil)
322-17982	17982	Green Drain Pan (For Coolant)

SINGLE WALL UL-142 CUBE LUBE TANK

- UL listed tanks - double wall • If tank is for used oil, a high level tank monitor is recommended



ASCOT NO.	MFG. NO.	DIMENSIONS (H X W X D)	THICKNESS	APPROX. WEIGHT
322-00125	DW125	38"x32"x26"	12 Gauge	170 lb.
322-00200	DW200	36"x60"x22"	12 Gauge	220 lb.
322-00201	DW200V	60"x36"x22"	12 Gauge	220 lb.
322-00250	DW250	34"x60"x28"	12 Gauge	290 lb.
322-00251	DW250V	60"x34"x28"	12 Gauge	290 lb.
322-00300	DW300	38"x60"x31"	12 Gauge	325 lb.
322-00301	DW300V	60"x38"x31"	12 Gauge	325 lb.
322-00350	DW350V	60"x41"x31"	12 Gauge	350 lb.
322-00500	DW500	60"x60"x33"	12 Gauge	450 lb.
322-00650	DW650	60"x78"x33"	10 Gauge	730 lb.
322-00750	DW750	60"x90"x33"	10 Gauge	820 lb.
322-01000	DW1000	60"x118"x33"	10 Gauge	1,025 lb.



8-GALLON OIL LIFT DRAIN

- This specially shaped, translucent jug holds 8 gallons • Reinforced base will not warp with hot oil • Has a wide working range from 36 1/2" to 74" • Its lower center of gravity increases stability and four 2 1/2" ball bearing wheels swivel and roll easily • Also has a heavy-duty adjustment clamp, large handle and big pour spout with threaded cap • Large 15" funnel has strainer built-in to catch drain plugs • Base of funnel is 1 3/4" wide



322-11102



ASCOT NO.	MFG. NO.	DESCRIPTION
322-11102	11102	8-Gallon Oil Lift Drain



18-GALLON OIL LIFT DRAIN

- Translucent jug holds 18 gallons and will not warp with hot oil • Rolls easily with four heavy-duty 2 1/2" wheels • Metal tubes extend working area from 36-1/2" to 77" • Drains from the bottom with a brass drain valve • Large 15" funnel has a built in strainer to catch drain plugs



322-17432



ASCOT NO.	MFG. NO.	DESCRIPTION
322-17432	17432	18-Gallon Oil Lift Drain



18-GALLON OIL LIFT DRAIN

- 18-gallon capacity • Four 3-1/2" ball bearing wheels • 3/4" evacuation valve • Spout for evacuation • Hand grips on bottom and top • Height adjusts from 48" to 71" • Polyethylene body is translucent for easy viewing of oil level • Oil Drain Pump not included

322-24026



ASCOT NO.	MFG. NO.	CAPACITY	HEIGHT (MAX.)	HEIGHT (MIN.)
322-24019	2400-19	18-Gallon	71"	48"
322-24026	2400-26	Oil Drain Pump		



8-GALLON OIL LIFT DRAIN

- 8-gallon capacity • Spout for evacuation • Hand grips on bottom and top for ease in evacuation • Four 3-1/2" ball bearing wheels • Height adjusts from 48" to 71" • Polyethylene body is translucent for easy viewing of oil level

322-24020



ASCOT NO.	MFG. NO.	CAPACITY	HEIGHT (MAX.)	HEIGHT (MIN.)
322-24020	2400-20	8-Gallon	71"	48"

Fluid Exchange

COOL-TECH 34288NI RECOVERY/RECYCLING SYSTEM

- **AUTOMATIC OIL DRAIN:** Automatically drains oil recovered during the recovery operation and puts the oil in a graduated container showing the user how much needs to be injected back into the system
- **AUTOMATIC AIR PURGE:** Eliminates damaging air without monitoring gauges or opening valves
- **PROGRAMMABLE VACUUM FUNCTION:** Defaults to 15 mins, programmable up to 99 mins. "Remaining time" is displayed
- **OPTIONAL REFRIGERANT & OIL DATABASE:** A/C system capacities for North American market vehicles (Not included with the machine)



361-34288

ASCOT NO.	MFG. NO.	DESCRIPTION	DIMENSIONS	SHIPPING WT.
361-34288	34288NI	Recovery/Recycling System	50" H x 34" W	225 lb.

COOL-TECH 34788NI RECOVERY/RECYCLING SYSTEM

- Fully automatic operation • 98.5% recovery • R134a • **IMPROVED CHARGE PERFORMANCE:** Exceeds SAE requirements
- Graphical display • **EXPANDABLE:** Capable of additional feature and function add-ons (printer, wireless, refrigerant ID) • Automatic Internal tank fill



361-34788

ASCOT NO.	MFG. NO.	DESCRIPTION	SHIPPING WT.
361-34788	34788NI	Recovery/Recycling System	235 lb.
361-34789	34788NI-H	Hybrid Recovery/Recycling System	222 lb.



PREMIUM 34988NI A/C RECOVER, RECYCLE AND RECHARGE MACHINE

- Fully automatic recovery, vacuum leak test and recharge - no monitoring required
- Patented automatic refrigerant refill prevents machine from emptying supply tank
- Only machine with fully automatic oil injection
- Two oil inject bottles for different oils to work on more vehicles with less down time
- Large easy-to-read color display and printer standard
- UV dye injection capability for leak detection
- Automatic air purge eliminates system-damaging air



361-34988

ASCOT NO.	MFG. NO.	DESCRIPTION	SHIPPING WT.
361-34988	34988NI	Recovery/Recycling System	232 lb.

PREMIER R-1234YF RECOVER, RECYCLE AND RECHARGE MACHINE

- 98.5% recovery efficiency • Charge accuracy within +/- 1/2 oz.
- **FULLY AUTOMATIC OPERATION:** Program for service, walk away and return when complete
- Automatic internal tank refill. No stopping to fill the internal tank during service, or before service
- Automatic oil drain shows how much oil was removed from the system during service
- Integrated refrigerant identifier
- Programmable vacuum operation helps get to the necessary vacuum level in any condition quickly
- System leak test to identify gross leaks in a system
- 5 x 9 cm (4.3-in. diag) Color graphical display
- Exceeds SAE J2843 requirement for R-1234YF Recover, Recycle and Recharge equipment



361-11234

ASCOT NO.	MFG. NO.	DESCRIPTION	SHIPPING WT.
361-11234	AC1234-4	Premier R-1234yf Recover, Recycle and Recharge Machine	206 lb.



The FX Series is the new Gold Standard in Refrigerant Management. Quickly and efficiently recover, recycle, and recharge automotive A/C systems with the FX Series of Refrigerant Management Centers. FEATURES: 7" Color touch screen control panel, patented motor-controlled ball valves, patented oil-less compressor, 1-2-5 Warranty (1 year - Labor / 2 years - Parts / 5 years - Compressor), 30 lb. recovery tank, 6 CFM vacuum pump, Hybrid compatible, Thermal printer standard on all models

*Setup and training are provided at no additional charge.

FX134A REFRIGERANT MANAGEMENT SYSTEM

- Certified to meet SAE J2788H for use in R134A systems

FX1234 REFRIGERANT MANAGEMENT SYSTEM

- Certified to meet SAE J2843 for use in R1234yf systems
- Includes a Refrigerant Identifier

FX3030 DUAL REFRIGERANT MANAGEMENT SYSTEM

- Certified to meet SAE J3030 for use in R134a and R1234yf systems
- Includes a Refrigerant Identifier
- **DUAL UNIT HANDLING BOTH REFRIGERANTS**



361-00134



361-01234



361-03030

ASCOT NO.	MFG. NO.	DESCRIPTION
361-00134	FX134A	FX134A Refrigerant Management System

ASCOT NO.	MFG. NO.	DESCRIPTION
361-01234	FX1234	FX1234 Refrigerant Management System

ASCOT NO.	MFG. NO.	DESCRIPTION
361-03030	FX3030	FX3030 Refrigerant Management System

AUTO & FLEET SERVICE

Oil Accessories



6-QT. OIL DISPENSER

- Translucent white (see-through) polyethylene material enables the user to read the liquid level on the container
- Marked in both quarts and liters
- The flexible 8" pouring spout enables easy transfer of liquid
- The spout is white



ASCOT NO.	MFG. NO.	DESCRIPTION
329-19732	19732	6-Quart Oil Dispenser

329-19732

RADIATOR FILLERS

- Long curved spout, balanced shape and handle positions
- Weather resistant plastic
- 12-quart capacity



329-00505

ASCOT NO.	MFG. NO.	DESCRIPTION	CAPACITY
329-00505	6110-010	Black Plastic Radiator Filler	12 Quarts

8-QT. OIL DISPENSER WITH LID & CAP

- 8-Quart Dispenser with a spout cap and lid to keep out dirt, dust and other contaminants
- Many large SUVs and trucks now require more oil — works great to transport bulk oil
- Translucent white polyethylene material enables the user to read the oil level on the container up to 8 quarts and is marked in both quarts and liters
- Flexible, removable 8" pouring spout enables easy transfer of liquid



329-19702



ASCOT NO.	MFG. NO.	DESCRIPTION
329-19702	19702	8-Quart Oil Dispenser with Lid & Cap



WATER/ANTI-FREEZE BIBB

- Durable, full volume dispense nozzle for water, windshield wash and antifreeze
- 1/4" NPT female inlet



329-18685

ASCOT NO.	MFG. NO.	DESCRIPTION
329-18685	3340-014	Water/Anti-Freeze Bib

AUTO & FLEET SERVICE



SLIP JOINT HANDLE OIL FILTER PLIERS

• Two-position, slip-joint handle produces the range of three separate conventional filter wrenches • Overall range 2 1/4" to 4" • Jaws are bent at a 20-degree angle to fit more applications • Sure grip teeth prevent slipping • Cushioned handles provide comfort • **OVERALL LENGTH: 11-1/2"**

TWO-POSITION, SLIP-JOINT HANDLE



329-50750

ASCOT NO.	MFG. NO.	DESCRIPTION
329-50750	50750	Slip Joint Handle Oil Filter Pliers

SWIVEL GRIP OIL FILTER WRENCHES

• Handle swivels to clear obstructions • Features the swivel handle, gripper "teeth" and 1" wide stainless steel band • The swivel handle makes it easy to turn filters in hard to reach locations • Vinyl covered handle

HANDLE SWIVELS FOR EASE OF USE



329-53500

ASCOT NO.	MFG. NO.	DESCRIPTION
329-53500	53500	Standard Swivel Grip Oil Filter Wrench: 3.5" - 3.875" Range
329-53700	53700	Small Swivel Grip Oil Filter Wrench: 2.875" - 3.25" Range

HEAVY DUTY END CAP OIL FILTER WRENCHES

End cap filter wrenches have been improved by adding welds to hold a steel disc to the top of the wrench.

- Cup design allows easy filter removal and installation from the end of the filter, even in the tightest locations • End cap filter wrenches fit the most popular domestic and import vehicles • 14 flutes • Use with 3/8 in. square drive
- These low-profile sockets are specially designed for operating clearance
- Welded steel disc on top for extra strength • Heat treated steel • 3/8" drive



329-61570

HEAT-TREATED STEEL

ASCOT NO.	MFG. NO.	DESCRIPTION
329-61570	61570	Heavy Duty End Cap Oil Filter Wrench: 76 mm - 14 Flutes
329-61600	61600	Heavy Duty End Cap Oil Filter Wrench: 65 mm - 14 Flutes

IMPORT CAR OIL FILTER WRENCH

• Fits filters from 2 1/2" to 3 1/8" • Removes all oil filters from 2 1/2" to 3 1/8" in diameter • This extra large range enables the 63600 wrench to fit most all import car filters plus the common 3" domestic car filters • Steel jaws grip filter without slipping • Works in tight spots from the front of the filter using 3/8" drive

WORKS IN TIGHT SPOTS

NON-SLIP STEEL JAWS



329-63600

ASCOT NO.	MFG. NO.	DESCRIPTION
329-63600	63600	Import Car Oil Filter Wrench

Safety Products



FACE SHIELDS

ASCOT NO.	MFG. NO.	DESCRIPTION
396-14955	14955	170-SB Crown and Window Kit
396-14200	14200	MAXVIEW™ Premium Face Shield - Clear Window
396-21000	21000	GPL500 Premium Goggle with Flip-Up Detachable Shield - Clear Lens, Anti-Fog

396-14955



396-14200

JACKSON

396-21000

SAFETY GLASSES

- Lightweight, stylish, comfortable and very affordable • High impact optically correct wrap style unitary PC lens offers superior coverage • Soft, flexible temple tips & soft nose piece offers all day comfort • Temples are curved inwards to ensure comfortable, slip-resistant fit • Temple tips are curved outwards for gentle placement and removal
- Meets ANSI Z87.1-2015 and tested to U.S. Military Standard MIL-PRF-31013
- Available in clear/black, amber/black and smoke/black styles

ASCOT NO.	MFG. NO.	DESCRIPTION
396-73601	S73601	Sellstrom XM330 Safety Glasses - Clear/Black
396-73611	S73611	Sellstrom XM330 Safety Glasses - Amber/Black
396-73621	S73621	Sellstrom XM330 Safety Glasses - Smoke/Black



396-73601



396-73611



396-73621

HEARING PROTECTION

ASCOT NO.	MFG. NO.	DESCRIPTION	FEATURES
396-20773	20773	Jackson H70 Vibe Earmuffs - Orange	Highly padded ear cups for all day comfort, Dielectric, durable thermoplastic material retains shape and pressure, Great for environments such as lawn mowers, industrial work, traffic noise, etc.
396-23412	S23412	Sellstrom Disposable Ear Plugs - FOAM Bullet Shape, Corded, Hi-Viz Green (100 pairs per box)	Gently but quickly expand to fit ear canal, Soft non-irritating PU foam for max comfort, Independently tested/certified to NRR 32 (ANSI S3.19), CSA Class AL.
396-23421	S23421	Sellstrom Reusable Ear Plugs - Tapered, Corded, Blue/Hi-Viz Green (100 pairs per box)	Ensure optimum ear canal coverage, Firm push/pull post for easy insertion/removal, Reusable - Can be washed and reused, Non-allergenic polymer materials
396-23430	S23430	Sellstrom Banded Ear Plugs - Tapered, Hi-Viz Green (1 per bag)	Wear around the neck when not in use, Regular and intermittent applications - Easily removed, Band shape curves at the plug end to keep pods up and clean when not in use



396-20773



396-23430



396-23421



TEAR AWAY MESH SAFETY VESTS

- Meets visibility standards and requirements for medium risk traffic control and public safety workers, including school crossing guards, survey crews and more • COOLING COMFORT - Polyester mesh is breathable, durable and keeps you cool on the job • HI-VIS - Includes StarTech reflective tape for excellent visibility • Features 5 point tear-away and D-ring access slot



396-30561

396-30551

ASCOT NO.	MFG. NO.	DESCRIPTION
396-30551	V1030550U-S/M	Safety Vest - Hi-Vis Orange, Size S/M
396-30552	V1030550U-L/XL	Safety Vest - Hi-Vis Orange, Size L/XL
396-30553	V1030550U-2/3XL	Safety Vest - Hi-Vis Orange, Size 2XL/3XL
396-30554	V1030550U-4/5XL	Safety Vest - Hi-Vis Orange, Size 4XL/5XL
396-30561	V1030560U-S/M	Safety Vest - Hi-Vis Yel/Green, Size S/M
396-30562	V1030560U-L/XL	Safety Vest - Hi-Vis Yel/Green, Size L/XL
396-30563	V1030560U-2/3XL	Safety Vest - Hi-Vis Yel/Green, Size 2XL/3XL
396-30564	V1030560U-4/5XL	Safety Vest - Hi-Vis Yel/Green, Size 4XL/5XL

KNEE PADS - ULTRA FLEX III

- Articulating hinge ensures proper placement all day • Soft elastic and wide straps are well placed and above the knee - No velcro • Strong & flexible plastic outer shells • Pads offer 5/8" closed cell foam pad, Sweat will not penetrate • Built for years of hard work and heavy use



396-96110

ASCOT NO.	MFG. NO.	DESCRIPTION
396-96110	S96110	KneePro Ultra Flex III Knee Pads - Grey/Orange

EYE WASH STATIONS

- The ideal first response solution when continuous water supply is unavailable • Quickly flushes contaminants from eyes using a sterile, buffered & preserved solution • Can be wall-mounted or placed on flat surfaces • Highly visible green backboard • Available in 6 gallon personal station or 32 oz. bottle station



396-90333



396-90306

ASCOT NO.	MFG. NO.	DESCRIPTION
396-90306	S90306	Sellstrom 6-Gallon Gravit-Eye Portable Eyewash Station
396-90333	S90333	Sellstrom 32 oz. Double Rapid-Clear Eyewash Bottle Station



DOT CONSPICUITY TAPE

- Meets all Federal and State certifications • Micro prismatic technology • Thin and flexible • 10-year durability



396-62150

ASCOT NO.	MFG. NO.	DESCRIPTION
396-62150	CT6R6W2150	2" x 150' (6" Red, 6" Silver)
396-72182	CT11R7W2X18	2" x 18" Strip (11" Red, 7" Silver)
396-72150	CT11R7W2150	2" x 150' (11" Red, 7" Silver)
396-82150	CTR2150	2" x 150' Solid Red
396-92150	CTW 2150	2" x 150' Solid Silver
396-93150	CTY2150	2" x 150' Solid Yellow

Wheel Chocks

RUBBER WHEEL CHOCK

• Durable rubber construction • Features an eye bolt for chain or rope attachment • Ribbed pyramid design • Either side of wheel chock can be positioned against the tire • Sold individually • WEIGHT: 10 lb. (4.5kg)

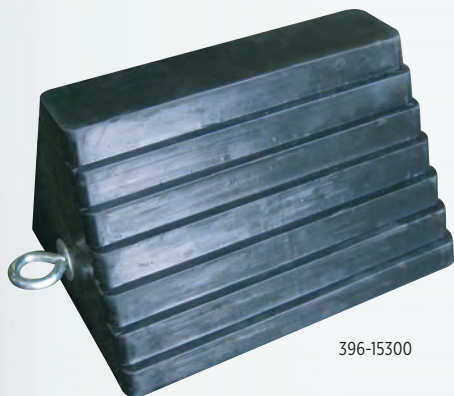

396-15300

ASCOT NO.	MFG. NO.	DESCRIPTION
396-15300	15300	Rubber Wheel Chock

OTR WHEEL CHOCK

• DIMENSIONS: 12" x 10" x 12" • Designed for heavy duty truck and mining equipment • 20" rope attached for convenience • NET WEIGHT: 27.5 lb.



396-00102

ASCOT NO.	MFG. NO.	DESCRIPTION
396-00102	TS102	OTR Wheel Chock

URETHANE WHEEL CHOCKS

• SOLID LIGHTWEIGHT CONSTRUCTION • High impact urethane material • Non-conductive, no threat to puncture the tire • Durable, lightweight and easy to use • Extensively field tested



396-15336



396-15338



396-15337



396-15339



396-15342



396-15353

ASCOT NO.	MFG. NO.	TIRE SIZE	DIMENSIONS (LXWXH)	WEIGHT
396-15336	15336	35" to 55" (90 cm to 140 cm)	13.3" x 8.6" x 7.8" (34 cm x 22 cm x 20 cm)	7.7 lb. (3.5 kg)
396-15337	15337	47" to 86" (120 cm to 220 cm)	18" x 12" x 9" (47.5 cm x 30.5 cm x 22.5 cm)	13 lb. (6 kg)
396-15338	15338	70" to 118" (180 cm to 300 cm)	22.5" x 13" x 14" (57 cm x 34 cm x 35.5 cm)	19.8 lb. (9 kg)
396-15339	15339	110" to 165" (280 cm to 420 cm)	26.7" x 13" x 14" (68 cm x 33.7 cm x 35.5 cm)	30.86 lb. (14 kg)
396-15342	15342	86" to 137.8" (220 cm to 350 cm)	24" x 13.5" x 12" (62.1 cm x 34.3 cm x 32.3 cm)	24.3 lb. (11 kg)
396-15353	15353	47" to 70" (120 cm to 180 cm)	13.38" x 9.84" x 7.8" (34 cm x 25 cm x 22.5 cm)	13.66 lb. (6.2 kg)

Gloves



NITRILE GLOVES

- For industrial and automotive applications
- Powder-free
- THICKNESS: 4.5 mil
- QUANTITY: 100 per box, 10 boxes per case

ASCOT NO.	MFG. NO.	DESCRIPTION
396-00802	BLK-M	Black Nitrile Gloves (Medium)
396-00803	BLK-L	Black Nitrile Gloves (Large)
396-00804	BLK-XL	Black Nitrile Gloves (XL)
396-00805	BLK-XXL	Black Nitrile Gloves (XXL)



RPG NITRILE MICRO-DIAMOND GLOVES

- Textured finish • For industrial and automotive applications • Powder-free
- THICKNESS: 6 mil Not made from natural rubber latex • QUANTITY: 100 per box, 10 boxes per case



396-00301

396-00401

ASCOT NO.	MFG. NO.	DESCRIPTION
396-00301	32806BK240R2	Micro Diamond Black Nitrile Glove (Small)
396-00302	32806BK240R3	Micro Diamond Black Nitrile Glove (Medium)
396-00303	32806BK240R4	Micro Diamond Black Nitrile Glove (Large)
396-00304	32806BK240R5	Micro Diamond Black Nitrile Glove (XL)
396-00305	32806BK240R6	Micro Diamond Black Nitrile Glove (XXL)
396-00401	32806OR240R2	Micro Diamond Orange Nitrile Glove (Small)
396-00402	32806OR240R3	Micro Diamond Orange Nitrile Glove (Medium)
396-00403	32806OR240R4	Micro Diamond Orange Nitrile Glove (Large)
396-00404	32806OR240R5	Micro Diamond Orange Nitrile Glove (XL)
396-00405	32806OR240R6	Micro Diamond Orange Nitrile Glove (XXL)



RPG MECHANIC'S GLOVES

- Black synthetic leather palm with small patches • Features blue spandex on back, neoprene on knuckle, 4cm wide elastic, hook & loop



396-10011

ASCOT NO.	DESCRIPTION
396-10011	RPG Mechanic's Gloves

HIGH VISIBILITY MECHANICS GLOVES

- Grey synthetic leather with silicon printing on palm • High visibility Spandex back with back of the hand protection • Impact protection • Hook and loop • One size fits most



396-14201

396-14202

ASCOT NO.	MFG. NO.	DESCRIPTION
396-14201	FGM-420	Green/Black Mechanics Gloves - Pair
396-14202	FOM-420	Orange/Black Mechanics Gloves - Pair

AUTO & FLEET SERVICE

Gloves (cont.)



WORK GLOVES

Gaither's Work Gloves are designed to provide the best possible protection while still delivering the grip and flexibility required for performing intricate and complex tasks.

- Perfect for tire maintenance and general shop use
- Machine washable
- Impact protection
- Double Stitched
- Industrial grade hook and loop
- Slip-free silicone grip



ASCOT NO.	MFG. NO.	DESCRIPTION
396-49101	G49110S	Small Work Gloves
396-49102	G49110M	Medium Work Gloves
396-49103	G49110L	Large Work Gloves
396-49104	G49110XL	Xtra Large Work Gloves

COLORED LEATHER DOUBLE PALM WORK GLOVES

- Split leather double palm
- Colored fabric on the back of the hand
- Half fleece lining
- 12 pairs per package



396-55221

396-55222

ASCOT NO.	MFG. NO.	DESCRIPTION
396-55221	AB-R	Red Leather Double Palm Work Gloves
396-55222	AB-G	Green Leather Double Palm Work Gloves

MISCELLANEOUS HAND PROTECTIVE GLOVES



396-06780



396-40317



396-55220

ASCOT NO.	DESCRIPTION
396-06780	Wet Grip Neoprene Glove. Protects Against Acids, Caustics, Oils, Greases And Many Solvents. 5-Piece Flannel Liner
396-40317	Power Grip with Latex Premium Grip
396-55220	Leather Palm Glove with Safety Cuff, Elastic

HIGH VISIBILITY DUAL COLOR LEATHER DOUBLE PALM GLOVES

- Split leather double palm
- High visibility green and orange colors
- Half fleece lining
- 12 pairs per package



396-55223

ASCOT NO.	MFG. NO.	DESCRIPTION
396-55223	AB-HVDC	High Visibility Dual Color Leather Double Palm Gloves